

3  
2017

the sofa bed collection

the sofa bed collection  
03  
2017

**alberta**<sup>®</sup>  
Made in Italy



alberta

**alberta**<sup>®</sup>  
Made in Italy

Ha ispirato la sofà bed collection la volontà di raggiungere con il valore estetico la portata del valore pratico che da sempre domina il concetto del divano letto. Abbiamo così unito un design raffinato e contemporaneo ad una comodità indiscutibile garantita dall'impiego di reti e materassi di grande qualità e dai semplicissimi meccanismi di apertura. Bandito il concetto di provvisorio. Sono nuove interpretazioni per nuove situazioni. Il risultato deve essere sempre impeccabile.

*Our collection of sofa beds has always been designed around combining great looks with practicality. By using only the highest quality mattresses and simple opening mechanisms our beautifully designed sofa beds are never a compromise between comfort and functionality. They are, simply, the best of both worlds. New ideas for new realities. The result, as ever, is impeccable.*

<b>ARGO</b>	03
<b>SPACE</b>	29
<b>RECANATI</b>	39
<b>MAISON</b>	54
<b>TOGO</b>	64

sequenze di apertura / <i>opening sequences</i>	79
guida alla scelta / <i>selection guide</i>	83
disegni tecnici / <i>technical drawings</i>	87
descrizioni tecniche / <i>technical descriptions</i>	94
<b>COMPANY PROFILE</b>	100



# ARGO

*exploring new comfort*

Componibilissimi dal disegno semplice e raffinato. Sofà che diventano letto, più letti e confortevoli dormeuse; perché non esistono solo sonno e veglia... c'è anche il relax.

*Incredibly flexible with simple, refined design.*

*ARGO is a sofa, a bed, separate beds or an incredibly comfortable place to lie down and take it easy.*

*Because sometimes we just need to sit back and relax.*





ARGO





ARGO







# ARGO









16 | PASHKTAVO40 - tavolino laccatura lucida bianca | coffee-table white glossy  
laquering | table basse laquage brillant blanc | Salontisch weiss glösslackiert

# ARGO









# ARGO



ARGO



ARGO



alberta.

# SPACE

*the final frontier*

L'assoluto della funzionalità si traduce in essenzialità dello stile. L'esigenza dello spazio diventa libera e personale interpretazione.

*Superior functionality meets simple, clean styling. Absolute freedom to make your space your own.*



SPACE  
the final frontier







## SPACE





SPACE





alberta.

# RECANATI

*a breath of fresh air*

Sotto lo stesso nome, RECANATI, spirito moderno e forma classica entrambi assolutamente attuali come la vera poesia. I tessuti personalizzano i versi con la naturalezza dei colori.

*RECANATI, modern spirit and classic design, both undeniably contemporary. A symphony of style with fabrics that bring natural colour and harmony to your home.*

# RECANATI

a breath of fresh air



RECANATI



RECANATI





# RECANATI



RECANATI





# RECANATI



alberta.

# MAISON

*my house my style*

Originalissimo nelle sue linee geometriche e nella soluzione pratica del rivestimento, MAISON è simbolo di casa. Casa allargata al piacere ed al sentimento dell'ospitalità.

*With unique geometric lines and a practical covering system MAISON means home. A home designed to be open, welcoming and enjoyed with friends.*





MAISON







MAISON



alberta.

# TOGO

*comfort for all season*

Più soluzioni per le diverse varianti dell'ospitalità. Tessuti naturali, caldi ed accoglienti per creare in ogni ambiente una sensazione familiare.

*A range of solutions to suit all your entertaining needs. Natural, warm, inviting fabrics that make every room feel comfortably familiar.*



# TOGO

comfort for all seasons





TOGO

S





# TOGO





TOGO





0TOGC5



0TOGC6



0TOGC7



0TOGC4





sequenze di apertura

*opening sequences*

**alberta.**

ARGO - SPACE - RECANATI - MAISON



ARGO



TOGO





guida alla scelta  
*selection guide*

**alberla.**

## MECCANISMI LETTI

bed mechanisms / la mécanique du lit / Bettmechanismen

ARGO - SPACE - RECANATI - MAISON



TOGO



## VARIANTI

options | options | Varianten

MATERASSO LUX / mattress lux / matelas lux / Matratze lux  
ARGO - SPACE - RECANATI - MAISON



MATERASSO LUX / mattress lux / matelas lux / Matratze lux  
TOGO



SISTEMA MECCANISMO RUOTE Wheel mechanism system | Système de mécanisme de roulettes | System mit Rädermechanismus  
ARGO - SPACE - RECANATI - MAISON

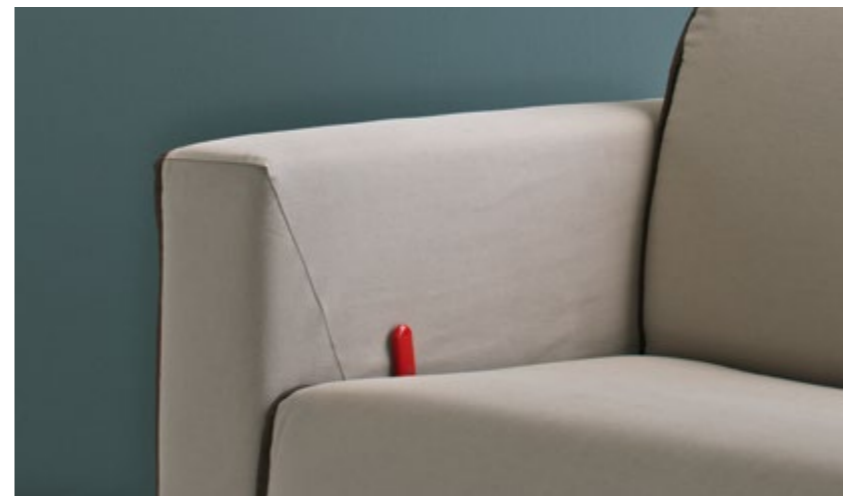



disegni tecnici  
*technical drawings*

**alberla**

# ARGO

Tessuto | fabric | tissu | Stoff



COMPOSIZIONI / COMPOSITIONS / COMPOSITIONS / KOMPOSITIONEN

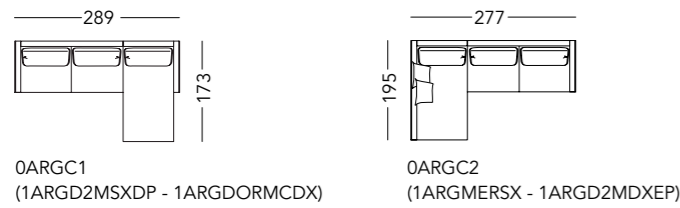

ELEMENTI / ELEMENTS / ELEMENTS / ELEMENTE

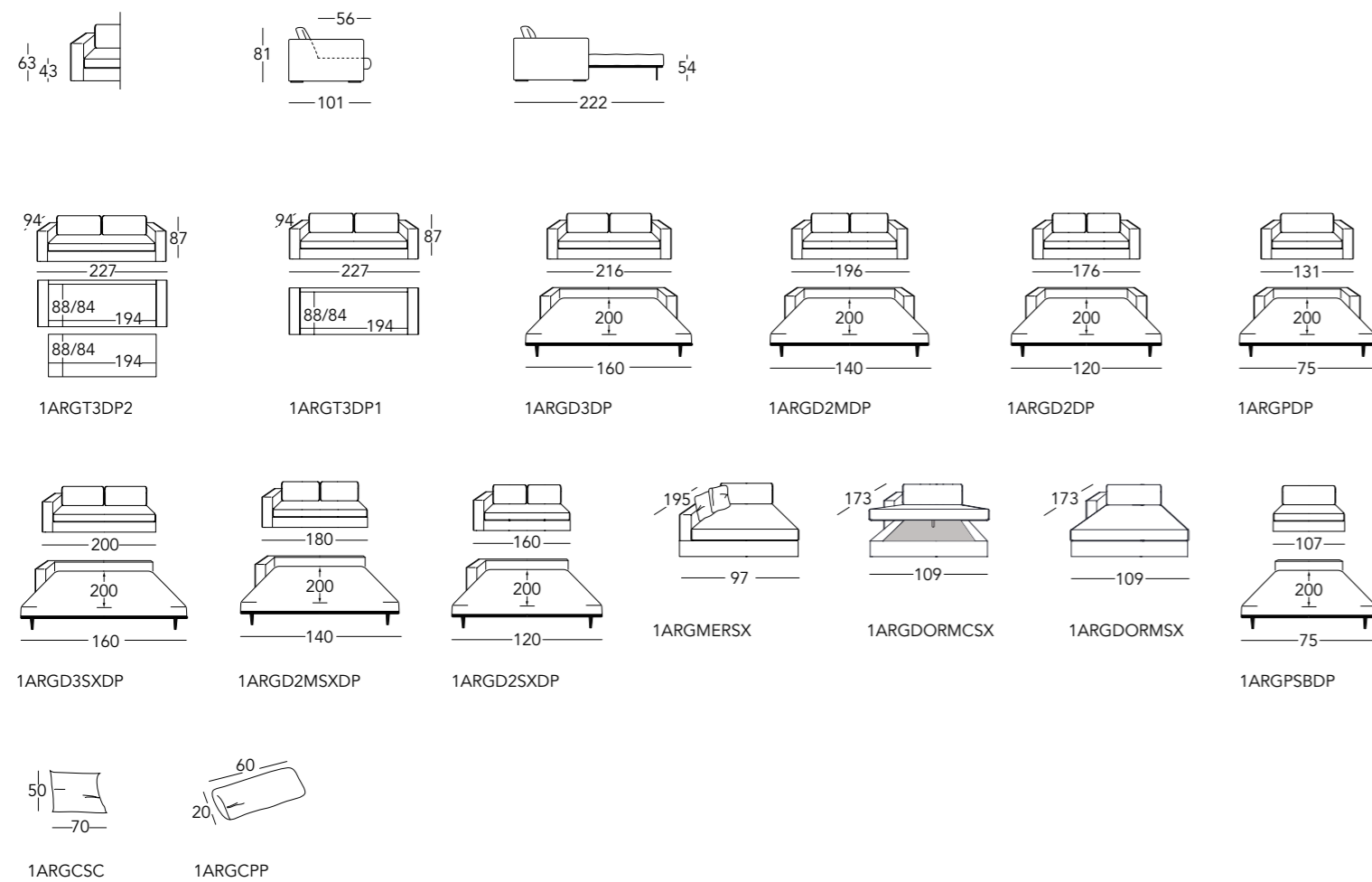

# SPACE

Tessuto | fabric | tissu | Stoff



COMPOSIZIONI / COMPOSITIONS / COMPOSITIONS / KOMPOSITIONEN

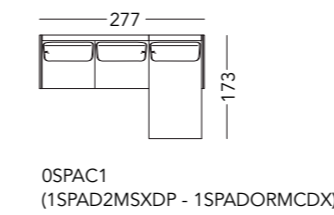

ELEMENTI / ELEMENTS / ELEMENTS / ELEMENTE

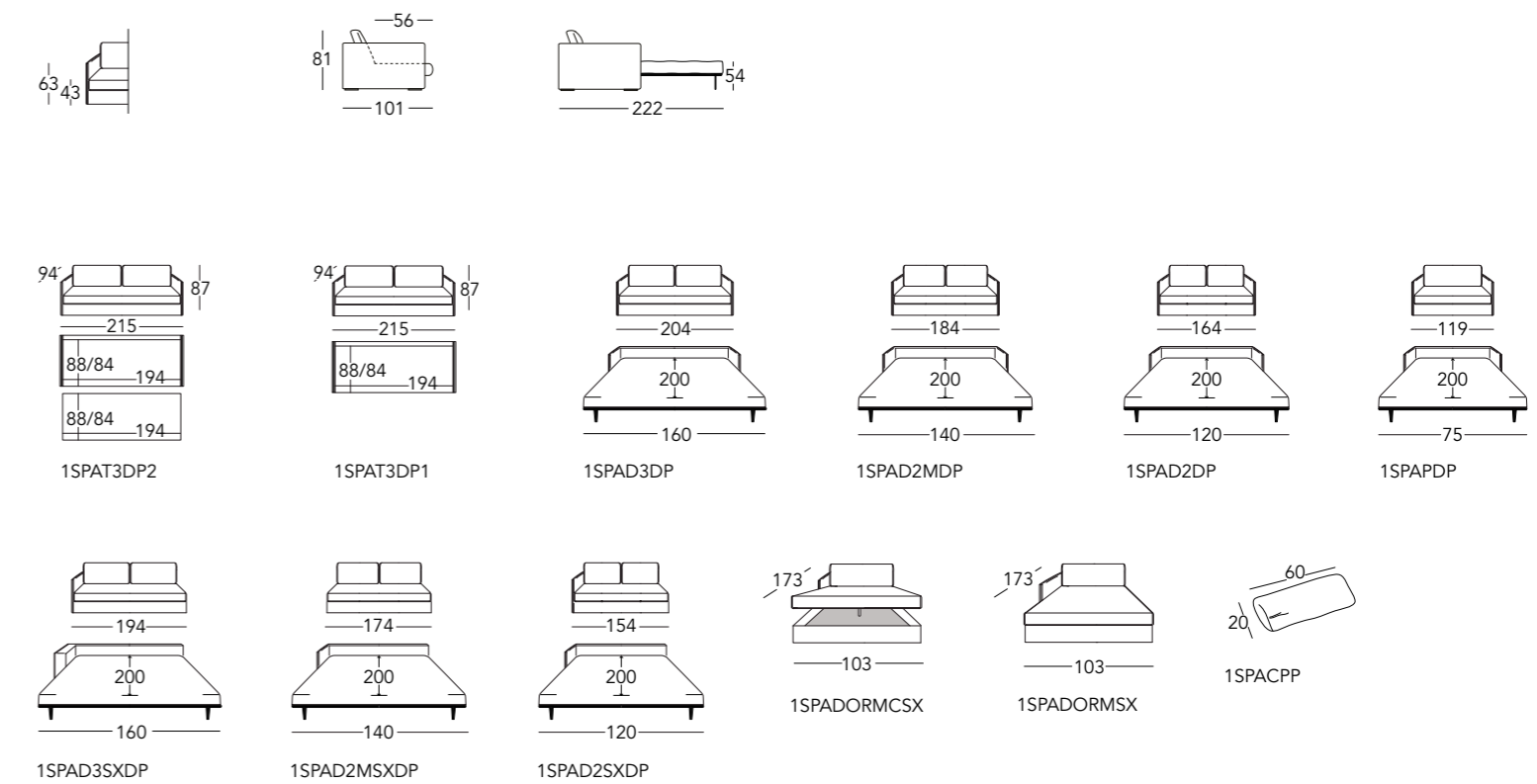

# RECANATI

Tessuto | fabric | tissu | Stoff



## COMPOSIZIONI / COMPOSITIONS / COMPOSITIONS / KOMPOSITIONEN

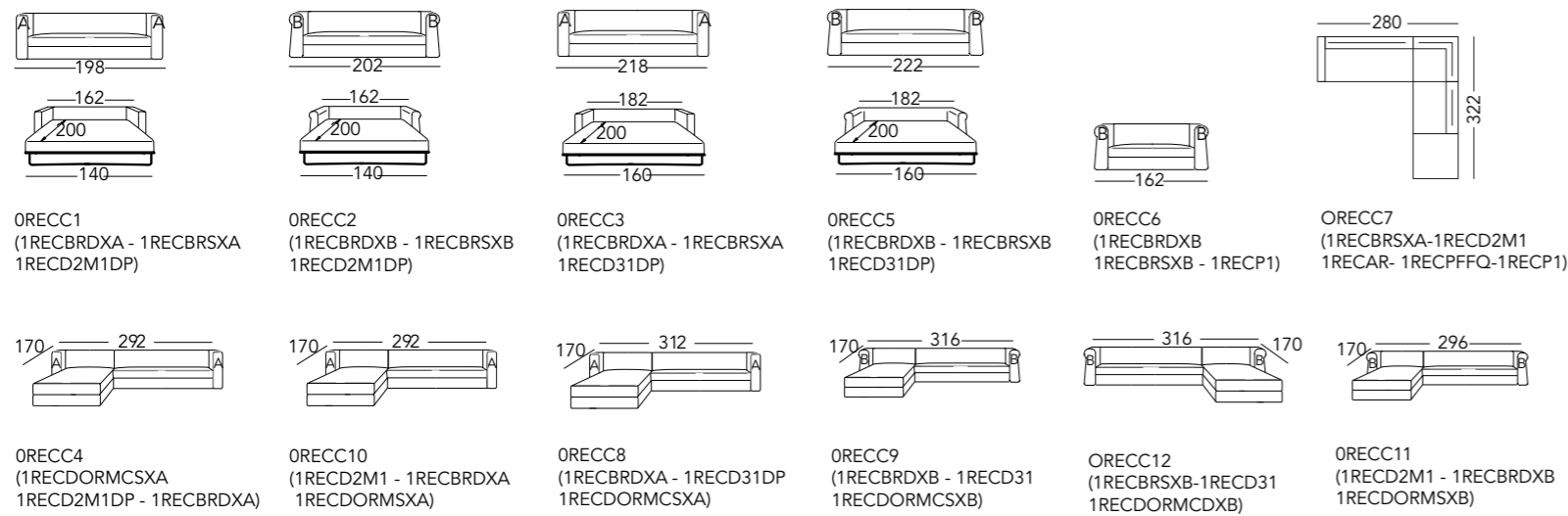

## ELEMENTI / ELEMENTS / ELEMENTS / ELEMENTE

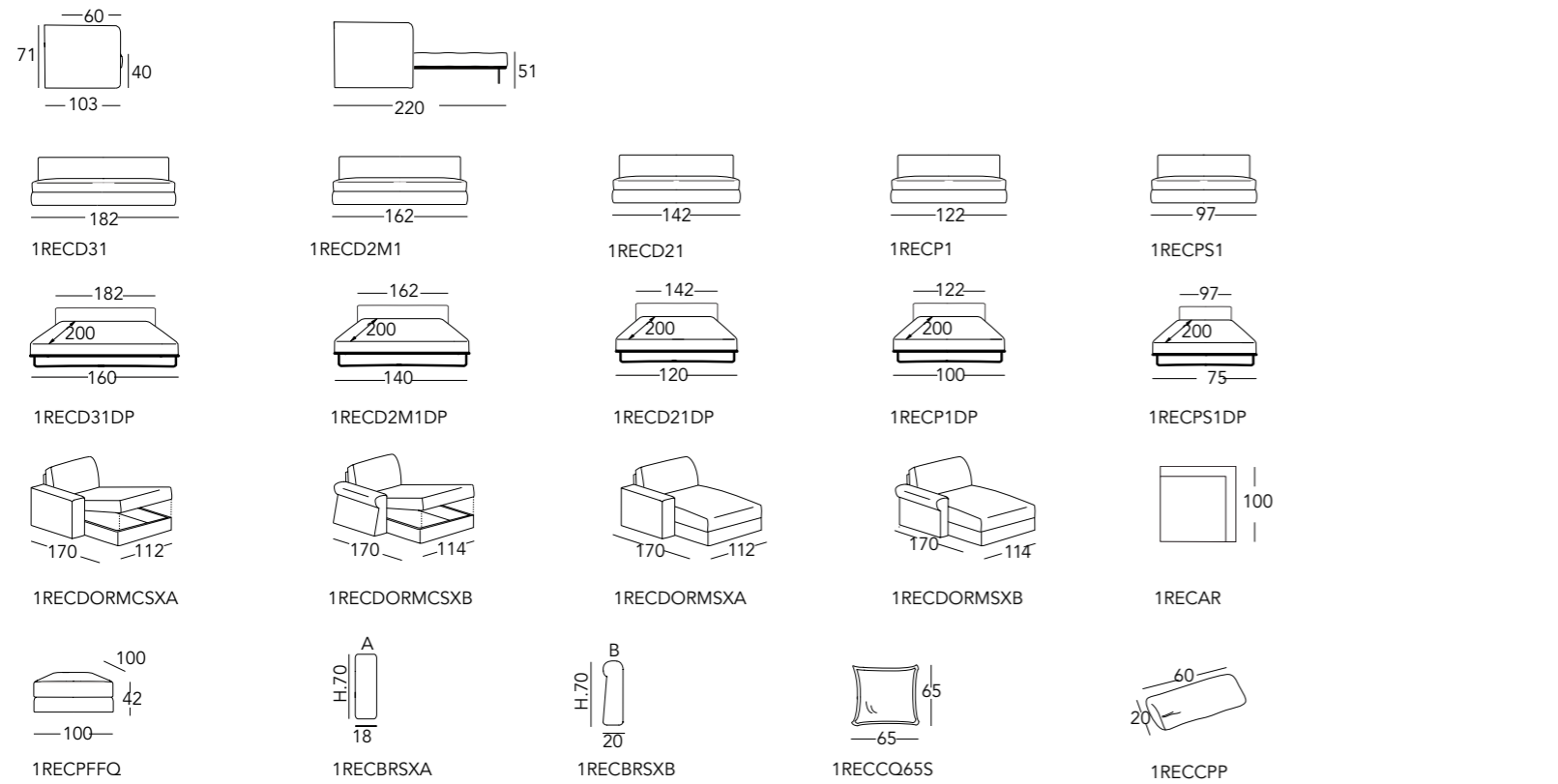

# MAISON

Tessuto | fabric | tissu | Stoff



## COMPOSIZIONI / COMPOSITIONS / COMPOSITIONS / KOMPOSITIONEN

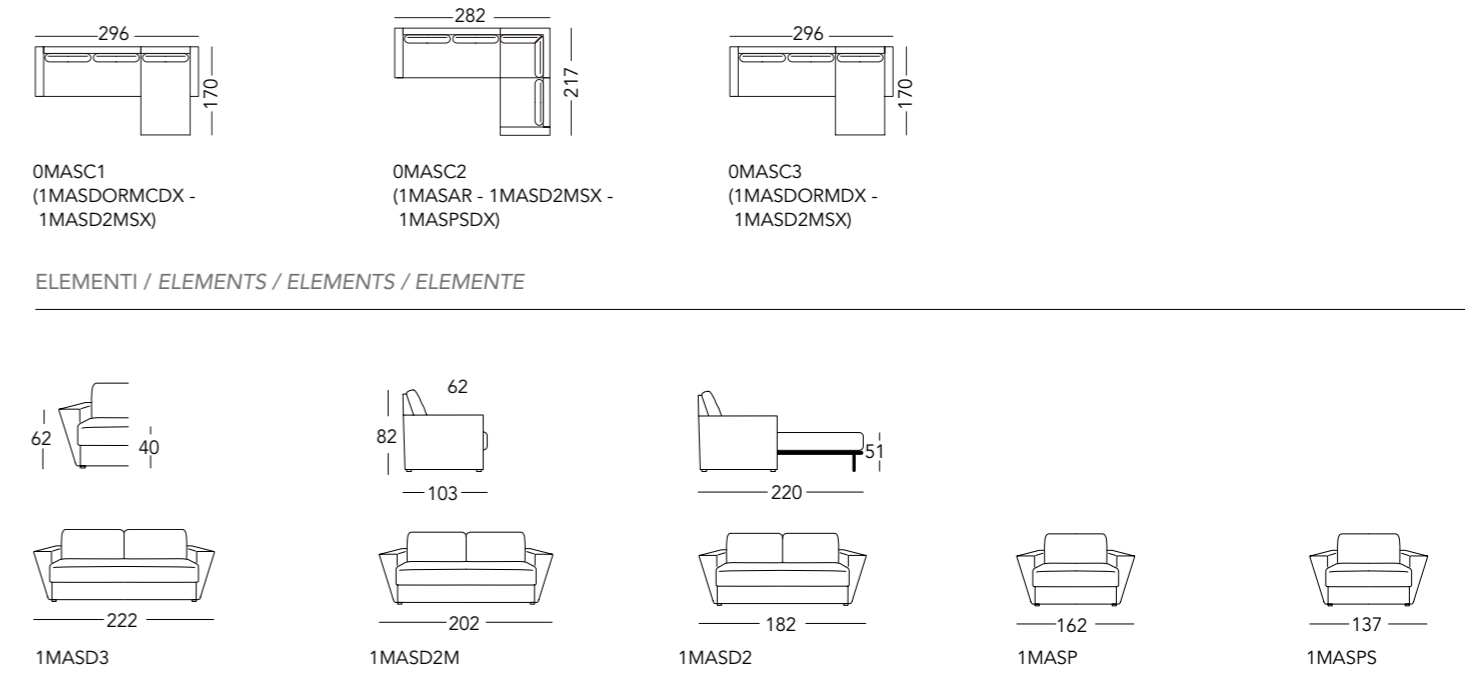

## ELEMENTI / ELEMENTS / ELEMENTS / ELEMENTE



# TOGO

Tessuto | fabric | tissu | Stoff



COMPOSIZIONI / COMPOSITIONS / COMPOSITIONS / KOMPOSITIONEN

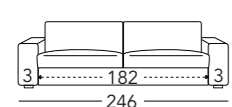

0TOGC1  
(1TOGD31EP - 1TOGBRSX3  
1TOGBRDX3)

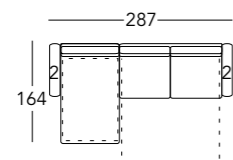

0TOGC2  
(1TOGD2M1EP - 1TOGDORMC1  
1TOGBRSX2 - 1TOGBRDX2)

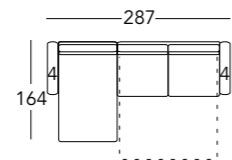

0TOGC3  
(1TOGD2M1EP - 1TOGDORM1  
1TOGBRSX4 - 1TOGBRDX4)

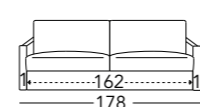

0TOGC4  
(1TOGD2M1EP  
1TOGBRSX1 - 1TOGBRDX1)

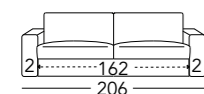

0TOGC5  
(1TOGD2M1EP  
1TOGBRSX2 - 1TOGBRDX2)

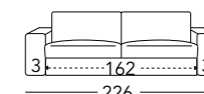

0TOGC6  
(1TOGD2M1EP - 1TOGBRSX3  
1TOGBRDX3)

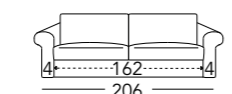

0TOGC7  
(1TOGD2M1EP - 1TOGBRSX4  
1TOGBRDX4)

ELEMENTI / ELEMENTS / ELEMENTS / ELEMENTE

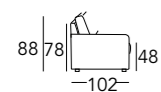

1TOGD31EP

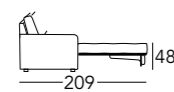

1TOGD2M1EP

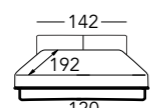

1TOGD21EP



1TOGDORM1

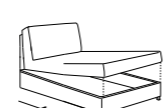

1TOGDORMC1

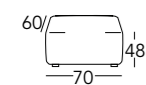

1TOGPFFR

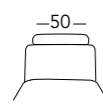

1TOGPT



1TOGBRSX1

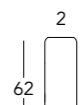

1TOGBRSX2

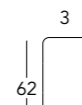

1TOGBRSX3

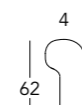

1TOGBRSX4

# SHAKE



ELEMENTI / ELEMENTS / ELEMENTS / ELEMENTE

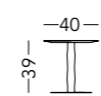

PASHKTAVO40

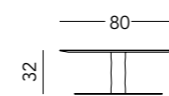

PASHKTAVO80

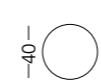

PASHKTAVO40



PASHKTAVO80





## descrizioni tecniche

technical descriptions

alberta

### ARGO

**Struttura portante** in massello di legno e suoi derivati.

**Imbottiture:** scocca e bracciolo in poliuretano espanso (densità 40 kg/mc); cuscino di seduta in poliuretano espanso a densità differenziata (40/35/30 kg/mc). Schienale in poliuretano espanso a densità differenziata (25/21 kg/mc). Seduta dormeuse e meridiana in poliuretano espanso densità 35 kg/mc; seduta divani sottoponte (cod.1ARGT3DP2-1ARGT3DP1) in poliuretano espanso a densità differenziata (40/35 kg/mc).

**Rete** in acciaio ad alta resistenza con supporto a doghe larghe in faggio e cinghie elastiche.

**Materasso:** STANDARD - in poliuretano espanso densità 25 kg/mc, rivestito con stoffa di cotone; LUX - in poliuretano espanso a densità differenziata (40/50 memory kg/mc), rivestito con tessuto trapuntato. MATERASSO SOTTOPONTE (cod.1ARGT3DP2-1ARGT3DP1) in poliuretano espanso densità 35 kg/mc, rivestito in resinato accoppiato con tessuto.

**Box contenitore** (solo su dormeuse): in laminato color grigio scuro.

**Piedino:** in ABS.

**Main structure** in solid wood and wood derivatives.

**Upholstery:** chassis and arm in polyurethane foam (density 40 kg/mc); seat cushion in polyurethane foam with different densities (40/35/30 kg/mc). Backrest in polyurethane foam with different densities (25/21 kg/mc). Dormeuse and meridiene seat in polyurethane foam (density 35 kg/mc); cod.1ARGT3DP2-1ARGT3DP1 seat in polyurethane foam with different densities (40/35 kg/mc).

High resistance steel **spring** with large beech wood slats and elastic belts support.

**Mattress:** STANDARD - in polyurethane foam (density 25 kg/mc) with cotton fabric cover; LUX - in polyurethane foam with different densities (40/50 memory kg/mc) and quilted fabric cover. Cod.1ARGT3DP2-1ARGT3DP1 are equipped with mattress in polyurethane foam (density 35 kg/mc), covered with resinat and fabric.

**Storage** (only for dormeuse): in dark grey laminated veneer.

**Feet:** in ABS.

**Structure** en bois massif et dérivés.

**Rembourrage:** structure et accoudoir en polyuréthane expansé (densité 40 kg/mc); assise en polyuréthane expansé en plusieurs densités (40/35/30 kg/mc). Dossier en polyuréthane expansé en plusieurs densités (25/21 kg/mc). Assise dormeuse et meridienne en polyuréthane expansé densité 35 kg/mc; assise canapés gigogne (cod.1ARGT3DP2-1ARGT3DP1) en polyuréthane expansé en plusieurs densités (40/35 kg/mc).

**Sommier** en acier haute resistance avec lattes en hêtre et sangles élastiques.

**Matelas:** STANDARD - en polyuréthane expansé 25 kg/mc, recouvert en tissu de coton; LUX - en polyuréthane expansé en plusieurs densités (40/50 memory kg/mc), recouvert en tissu matelassé. MATELAS CANAPE'GIGOGNE (cod.1ARGT3DP2-1ARGT3DP1) - en polyuréthane expansé 35 kg/mc, recouvert en tissu.

**Coffre** (seulement pour dormeuse): en bois stratifié coloris gris foncé.

**Pied:** en ABS.

**Struktur** aus Massivholz und seine Derivate.

**Polsterung:** Struktur und Armlehne aus Polyurethanschaum (Dichte 40 kg/m<sup>3</sup>); Sitzkissen aus Polyurethanschaum mit unterschiedlicher Dichte (40/35/30 kg/m<sup>3</sup>); Rücken aus Polyurethanschaum mit unterschiedlicher Dichte (25/21 kg/m<sup>3</sup>). Dormeuse und Meridiansitzen aus Polyurethanschaum, Dichte 35 kg/m<sup>3</sup>; Sofassitzen (Cod. 1ARGT3DP2-1ARGT3DP) aus Polyurethanschaum mit unterschiedlicher Dichte (40/ 35 kg/m<sup>3</sup>).

**Lattenrost** in hochfestem Stahl Unterstützung mit breiten Buchedauben und elastischen Gurten.

**Matratze:** STANDARD - in Polyurethanschaum Dichte 25 kg/m<sup>3</sup> mit Baumwolltuch bedeckt; LUX - in Polyurethanschaum mit unterschiedlicher Dichte (40/50 kg Memory/m<sup>3</sup>), mit gesteppten Stoffbezug. MATRATZE Cod. 1ARGT3DP2-1ARGT3DP in Polyurethanschaum Dichte 35 kg/m<sup>3</sup>, mit Stoffgekoppeltem Resinat beschichtet.

**Behälterkasten** (nur für Dormeuse): Laminat dunkelgrau.

**Fuß:** aus ABS.



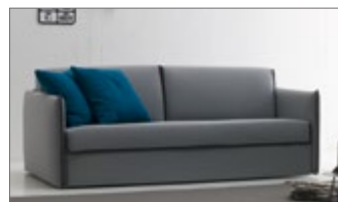

## SPACE

**Struttura portante** in massello di legno e suoi derivati.

**Imbottiture:** Scocca in poliuretano espanso (densità 40 kg/mc); bracciolo in poliuretano espanso (densità 40 kg/mc) rivestito in resinato accoppiato con vellutino; cuscino di seduta in poliuretano espanso a densità differenziata (40/35/30 kg/mc). Schienale in poliuretano espanso a densità differenziata (25/21 kg/mc). Seduta dormeuse e meridiana in poliuretano densità 35 kg/mc; Seduta divani sottoponte (cod. 1SPAT3DP2-1SPAT3DP1) in poliuretano espanso a densità differenziata (40/35 kg/mc).

**Rete** in acciaio ad alta resistenza con supporto a doghe larghe in faggio e cinghie elastiche.

**Materasso:** STANDARD - in poliuretano espanso densità 25 kg/mc, rivestito con stoffa di cotone; LUX - in poliuretano espanso a densità differenziata (40/50 memory kg/mc), rivestito con tessuto trapuntato. MATERASSO SOTTOPONTE (cod. 1SPAT3DP2-1SPAT3DP1) in poliuretano espanso densità 35 kg/mc, rivestito in resinato accoppiato con tessuto.

**Box contenitore** (solo su dormeuse): in laminato color grigio scuro.

**Piedino:** in ABS.

**Main structure** in solid wood and wood derivatives.

**Upholstery:** chassis in polyurethane foam (density 40 kg/mc); arm in polyurethane foam (density 40 kg/mc) covered with resinate and elastic velvet; seat cushion in polyurethane foam with different densities (40/35/30 kg/mc). Backrest in polyurethane foam with different densities (25/21 kg/mc). Dormeuse and meridienne seat in polyurethane foam (density 35 kg/mc); cod.1SPAT3DP2-1SPAT3DP1 seat in polyurethane foam with different densities (40/35 kg/mc).

High resistance steel **spring** with large beech wood slats and elastic belts support.

**Mattress:** STANDARD - in polyurethane foam (density 25 kg/mc) with cotton fabric cover; LUX - in polyurethane foam with different densities (40/50 memory kg/mc) and quilted fabric cover. Cod.1SPAT3DP2-1SPAT3DP1 are equipped with mattress in polyurethane foam (density 35 kg/mc), covered with resinate and fabric.

**Storage** (only for dormeuse): in dark grey laminated veneer.

**Feet:** in ABS.

**Structure** en bois massif et dérivés.

**Rembourrage:** structure en polyuréthane expansé (densité 40 kg/mc); accoudoir en polyuréthane expansé (densité 40 kg/mc) recouvert avec résiné couplé avec velour; assise en polyuréthane expansé en plusieurs densités (40/35/30 kg/mc). Dossier en polyuréthane expansé en plusieurs densités (25/21 kg/mc). Assise dormeuse et meridienne en polyuréthane expansé densités 35 kg/mc; assise canapés gigogne (cod.1SPAT3DP2-1SPAT3DP1) en polyuréthane expansé en plusieurs densités (40/35 kg/mc).

**Sommier** en acier haute resistance avec lattes en hêtre et sangles élastiques.

**Matelas:** STANDARD - en polyuréthane expansé 25 kg/mc, recouvert en tissu de coton; LUX - en polyuréthane expansé en plusieurs densités (40/50 memory kg/mc), recouvert en tissu matelassé. MATELAS CANAPE' GIGOGNE (cod.1ARGT3DP2-1ARGT3DP1) - en polyuréthane expansé 35 kg/mc, recouvert en tissu.

**Coffre** (seulement pour dormeuse): en bois stratifié coloris gris foncé.

**Pied:** en ABS.

**Struktur** aus Massivholz und seine Derivate.

**Polsterung:** Struktur aus Polyurethanschaum (Dichte 40 kg/m<sup>3</sup>); Armlehne aus Polyurethanschaum (Dichte 40 kg/m<sup>3</sup>) beschichtet mit Resinat Samt gekoppeltem; Sitzkissen aus Polyurethanschaum mit unterschiedlicher Dichte (40/35/30 kg/m<sup>3</sup>). Rücken aus Polyurethanschaum mit unterschiedlicher Dichte (25/21 kg/m<sup>3</sup>). Dormeuse und Meridiensitzen aus Polyurethanschaum, Dichte 35 kg/m<sup>3</sup>; Sofassitzen (Cod. 1SPAT3DP2-1SPAT3DP) aus Polyurethanschaum mit unterschiedlicher Dichte (40/ 35 kg/m<sup>3</sup>).

**Lattenrost** in hochfestem Stahl Unterstützung mit breiten Buchedauben und elastischen Gurten.

**Matratze:** STANDARD - in Polyurethanschaum Dichte 25 kg/m<sup>3</sup> mit Baumwolltuch bedeckt; LUX - in Polyurethanschaum mit unterschiedlicher Dichte (40/50 kg Memory/m<sup>3</sup>), mit gesteppten Stoffbezug. MATRATZE Cod. 1SPAT3DP2-1SPAT3DP in Polyurethanschaum Dichte 35 kg/m<sup>3</sup>, mit Stoffgekoppeltem Resinat beschichtet.

**Behälterkasten** (nur für Dormeuse): Laminat dunkelgrau.

**Fuß:** aus ABS.

## RECANATI

**Struttura portante** in massello di legno e suoi derivati.

**Imbottiture:** Scocca e bracciolo in poliuretano espanso (densità 40 kg/mc); cuscino di seduta in poliuretano espanso a densità differenziata (40/35/30 kg/mc). Schienale in poliuretano espanso a densità differenziata (40/35 kg/mc) .

**Rete** in acciaio ad alta resistenza con supporto a doghe larghe in faggio e cinghie elastiche.

**Materasso:** STANDARD - in poliuretano espanso densità 25 kg/mc, rivestito con stoffa di cotone; LUX - in poliuretano espanso a densità differenziata (40/50 memory kg/mc), rivestito con tessuto trapuntato.

**Box contenitore** (solo su dormeuse): in laminato color grigio scuro.

**Piedino:** in ABS.

**Main structure** in solid wood and wood derivatives.

**Upholstery:** chassis and arm in polyurethane foam (density 40 kg/mc); seat cushion in polyurethane foam with different densities (40/35/30 kg/mc). Backrest in polyurethane foam with different densities (40/35 kg/mc). High resistance steel **spring** with large beech wood slats and elastic belts.

**Mattress:** STANDARD - in polyurethane foam (density 25 kg/mc) with cotton fabric cover;

LUX - in polyurethane foam with different densities (40/50 memory kg/mc) and quilted fabric cover.

**Storage** (only for dormeuse): in dark grey laminated veneer.

**Feet:** in ABS.

**Structure** en bois massif et dérivés.

**Rembourrage:** structure et accoudoir en polyuréthane expansé (densité 40 kg/mc); assise en polyuréthane expansé en plusieurs densités (40/35/30 kg/mc); dossier en polyuréthane expansé en plusieurs densités (40/35 kg/mc).

**Sommier:** en acier haute resistance avec support à lattes en hêtre et sangles élastiques.

**Matelas:** STANDARD - en polyuréthane expansé 25 kg/mc, recouvert en tissu de coton; LUX - en polyuréthane expansé en plusieurs densités (40/50 memory kg/mc), recouvert en tissu matelassé.

**Coffre** (seulement pour dormeuse): en bois stratifié coloris gris foncé.

**Pied:** en ABS.

**Struktur** aus Massivholz und seine Derivate.

**Polsterung:** Struktur und Armlehne aus Polyurethanschaum (Dichte 40 kg/m<sup>3</sup>); Sitzkissen aus Polyurethanschaum mit unterschiedlicher Dichte (40/35/30 kg/m<sup>3</sup>). Rücken aus Polyurethanschaum mit unterschiedlicher Dichte (40/ 35 kg/m<sup>3</sup>).

**Lattenrost** mit hochfestem Stahl Unterstützung mit breiten Buchedauben und elastischen Gurten.

**Matratze:** STANDARD - in Polyurethanschaum Dichte 25 kg/m<sup>3</sup> mit Baumwollbezug; LUX - Polyurethanschaum mit unterschiedlicher Dichte (40/50 kg Memory/m<sup>3</sup>), mit gesteppten Stoffbezug.

**Behälterkasten** (nur für Dormeuse): Laminat dunkelgrau.

**Fuß:** aus ABS.

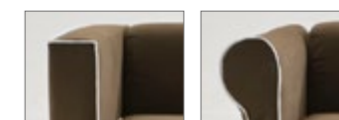



## MAISON

**Struttura portante** in massello di legno e suoi derivati.

**Imbottiture:** Scocca e bracciolo in poliuretano espanso (densità 40 kg/mc); cuscino di seduta in poliuretano espanso a densità differenziata (40/35/30 kg/mc). Schienale in poliuretano espanso a densità differenziata (40/30/21 kg/mc) rivestito in falda e vellutino accoppiato e trapuntato con resinato.

**Rete** in acciaio ad alta resistenza con supporto a doghe larghe in faggio e cinghie elastiche.

**Materasso:** STANDARD - in poliuretano espanso densità 25 kg/mc, rivestito con stoffa di cotone; LUX - in poliuretano espanso a densità differenziata (40/50 memory kg/mc), rivestito con tessuto trapuntato.

**Box contenitore** (solo su dormeuse): in laminato color grigio scuro.

**Piedino:** in ABS.

**Main structure** in solid wood and wood derivatives.

**Upholstery:** chassis and arm in polyurethane foam (density 40 kg/mc); seat cushion in polyurethane foam with different densities (40/35/30 kg/mc). Backrest in polyurethane foam with different densities (40/30/21 kg/mc) covered with synthetic wadding and elastic velvet quilted with resinato. High resistance steel **spring** with large beech wood slats and elastic belts support.

**Mattress:** STANDARD - in polyurethane foam (density 25 kg/mc) with cotton fabric cover;

LUX - in polyurethane foam with different densities (40/50 memory kg/mc) and quilted fabric cover.

**Storage** (only for dormeuse): in dark grey laminated veneer.

**Feet:** in ABS.

**Structure** en bois massif et dérivés.

**Rembourrage:** structure et accoudoir en polyuréthane expansé (densité 40 kg/mc); assise en polyuréthane expansé en plusieurs densités (40/35/30 kg/mc); dossier en polyuréthane expansé en plusieurs densités (40/30/21 kg/mc) recouvert en velour accouplé de polyamide matelassé avec resiné.

**Sommier:** en acier haute résistance avec support à lattes en hêtre et sangles élastiques.

**Matelas:** STANDARD - en polyuréthane expansé 25 kg/mc, recouvert en tissu de coton; LUX - en polyuréthane expansé en plusieurs densités (40/50 memory kg/mc), recouvert en tissu matelassé.

**Coffre** (seulement pour dormeuse): en bois stratifié coloris gris foncé.

**Pied:** en ABS.

**Struktur** aus Massivholz und seine Derivate.

**Polsterung:** Struktur und Armlehne aus Polyurethanschaum (Dichte 40 kg/m<sup>3</sup>); Sitzkissen aus Polyurethanschaum mit unterschiedlicher Dichte (40/35/30 kg/m<sup>3</sup>). Rücken aus Polyurethanschaum mit unterschiedlicher Dichte (40/30/21 kg/m<sup>3</sup>) mit gekoppeltem Schicht und Samt mit Resinat gesteppt.

**Lattenrost** mit hochfestem Stahl Unterstützung mit breiten Buchedauben und elastischen Gurten.

**Matratze:** STANDARD - in Polyurethanschaum Dichte 25 kg/m<sup>3</sup> mit Baumwollbezug; LUX - Polyurethanschaum mit unterschiedlicher Dichte (40/50 kg Memory/m<sup>3</sup>), mit gesteppten Stoffbezug.

**Behälterkasten** (nur für Dormeuse): Laminat dunkelgrau.

**Fuß:** aus ABS.

## TOGO

**Struttura portante** in massello di legno e suoi derivati.

**Imbottiture:** Scocca e bracciolo in poliuretano espanso (densità 30 kg/mc); cuscino di seduta in piuma d'oca e fibra di poliestere con inserto in poliuretano espanso densità 35 kg/mc. Cuscino di schienale in piuma d'oca e fibra di poliestere cava siliconata.

**Rete:** in acciaio ad alta resistenza con supporto in rete elettrosaldata (alloggiamento guanciali nel vano schienale).

**Materasso:** STANDARD - in poliuretano espanso densità 25 kg/mc, rivestito con stoffa di cotone; LUX - in poliuretano espanso a densità differenziata (40/50 memory kg/mc), rivestito con tessuto trapuntato.

**Piedino:** in ABS.

**Main structure** in solid wood and wood derivatives.

**Upholstery:** chassis and arm in polyurethane foam (density 30 kg/mc); seat cushion in goose feathers and polyester fibre with internal pillow in polyurethane foam (density 35 kg/mc). Back cushion in goose feathers and polyester fibre.

**Spring** in high resistance steel with electrically welded spring support (pillows box in the backrest).

**Mattress:** STANDARD - in polyurethane foam (density 25 kg/mc) with cotton fabric cover;

LUX - in polyurethane foam with different densities (40/50 memory kg/mc) and quilted fabric cover.

**Feet:** in ABS.

**Structure** en bois massif et dérivés.

**Rembourrage:** Structure et accoudoir en polyuréthane expansé (densité 30 kg/mc); coussin d'assise en plume d'oie et fibre de polyester avec insert en polyuréthane expansé densité 35 kg/mc. Coussin de dossier en plume d'oie et fibre de polyester.

**Sommier:** en acier haute résistance avec support sommier electrosoudé (rangements pour oreillers dans le coussin de dos).

**Matelas:** STANDARD - en polyuréthane expansé densité 25 kg/mc, recouvert en tissu de coton; LUX - en polyuréthane expansé en plusieurs densités (40/50 memory kg/mc), recouvert en tissu matelassé.

**Pied:** en ABS.

**Struktur** aus Massivholz und seine Derivate.

**Polsterung** Struktur und Armlehne aus Polyurethanschaum (Dichte 30 kg/m<sup>3</sup>); Sitzkissen aus Daunen und Polyesterfaser mit Polyurethanschaum-Teil Dichte 35 kg/m<sup>3</sup>. Rückenkissen aus Daunen und Silikonpolyesterfaser.

**Lattenrost:** aus Stahl mit Elektrogeschweißten Unterstützung (mit Box für Kissen im Rücken).

**Matratze:** STANDARD - Polyurethanschaum Dichte 25 kg/m<sup>3</sup> mit Baumwolltuch abgedeckt; LUX - Polyurethanschaum mit unterschiedlicher Dichte (40/50 kg Speicher/m<sup>3</sup>), mit gesteppten Stoff bedeckt.

**Fuß:** aus ABS.



## COMPANY PROFILE

Il marchio ALBERTA da oltre trent'anni rappresenta garanzia di qualità nella progettazione e nella produzione di divani e poltrone. L'azienda opera nel trevigiano, nord-est Italia, dal cui sostrato culturale ha attinto sia la tradizione artigiana sia l'attitudine alla creatività ed al design. Nel corso della sua storia ha sviluppato nei diversi stabilimenti linee di imbottiti sempre rispondenti all'evoluzione del gusto nelle due divisioni base che raggruppano le collezioni in tessuto e quelle in pelle. L'esperienza nell'impiego di entrambi i materiali consente ad Alberta di essere altamente propositiva. L'obiettivo dell'azienda è offrire soluzioni originali di ottimo livello estetico, pratico e qualitativo nel rispetto dei principi dell'etica ambientale.

*For over thirty years the ALBERTA brand has been recognised as a guarantee of quality in the design and production of sofas and armchairs. The company is headquartered in the Province of Treviso in the north east of Italy and has taken both its tradition of fine craftwork and its passion for creativity and design from this stimulating and active land. In order to meet the needs of ever-changing tastes the company has developed and now manufactures an extensive range of products based on two basic divisions, their textile and leather furniture collections. The experience they have gained working with these materials enables Alberta to be proactive and continually develop new solutions. The company mission is to create original products which combine great looks with practicality and quality while ensuring the utmost respect for the environment.*

*Le marque ALBERTA depuis plus de 30 ans c'est une garantie de qualité dans la projection et fabrication de fauteuils et canapés. L'usine opère dans la province de Treviso, nord-est de l'Italie, et du substrat culturel de cette zone elle a pris soit la tradition artisanale soit la disposition à la créativité et au design. Au cours de l'histoire elle a développé dans les différents usines des lignes des canapés toujours correspondant à l'évolution du goût dans les deux collections en cuir et tissu. L'expérience dans l'utilisations des matériaux a permis à Alberta d'être bien propositive avec ces collections. L'objectif de l'usine est offrir solutions originales de niveau esthétique, pratique et qualitatif excellent dans le respect des principes de l'éthique de l'ambiance.*

*Die Marke ALBERTA steht seit mehr als dreißig Jahren als Garantie für Qualität in der Entwicklung und Herstellung von Sofas und Sesseln. Das Unternehmen hat seinen Hauptsitz in der Provinz Treviso, im Nordosten Italiens. Angeregt von dieser Kultur und Landschaft schöpft Alberta sowohl aus der handwerklichen Tradition als auch aus der Begabung und Leidenschaft für Kreativität und Design. Im Laufe seiner Geschichte hat das Unternehmen in seinen verschiedenen Betrieben eine breite Palette von Polstermöbel entwickelt, die den Bedürfnissen der Kunden entgegenkommt. Dabei sind zwei grundlegende Richtungen entstanden: die Stoff- und die Lederkollektion. Die gewonnenen Erfahrungen in der Verwendung mit beiden Materialien ermöglicht Alberta sehr aktiv zu sein und ständig neue Lösungen zu entwickeln. Das Unternehmen hat sich zum Ziel gesetzt, originelle Lösungen mit hohen ästhetischen, praktischen und qualitativen Niveau anzubieten und gleichzeitig umweltfreundlich zu sein.*

La riproduzione totale o parziale è permessa esclusivamente su nostra autorizzazione.

Le immagini e i disegni contenuti nel presente catalogo sono puramente rappresentativi di questo prodotto e possono subire variazioni e modifiche anche senza preavviso.

Pertanto nella scelta degli articoli per la compilazione dell'ordine, fa fede solamente quanto contenuto nel listino in vigore.

*Reproduction, total or partial, is allowed exclusively under licence from our company.*

*The photographs and drawings in this catalogue are only a representation of products and may be varied and changed without notice.*

*When choosing article for your orders, only the details contained in the price-list in force should be considered.*

*La reproduction totale ou partielle est soumise exclusivement à notre autorisation.*

*Les images et les dessins présents dans ce catalogue sont uniquement des représentations de ce produit et peuvent subir des variations et des modifications même sans préavis.*

*Par conséquent, une fois les article choisis, lorsque vous remplirez le bon de commande, référez-vous au tarif en vigueur car il est le seul à faire foi.*

*Die Teilweise oder Gesamte Wiedergabe ist Ausschließlich mit unserer Erlaubnis gestattet.*

*Hinweis: Alle in diesem Katalog enthaltenen Abbildungen sind unverbindlich; wir behalten uns das Recht vor, Änderungen oder Verbesserungen ohne Ankündigung durchzuführen.*

*Maßgeblich für die Auswahl der einzelnen zu bestellenden Produkte ist ausschließlich die jeweils gültige Verkaufspreisliste.*

Photo: Fotorama  
Renai&Renai  
Romano fotografie d'arredamento

Design: Caseley Giovara

Art direction: Ufficio Stile Alberta Pacific Furniture

Graphic Assistant: Bplus marketing

Special thanks to: Showroom Targetti Milano  
Brita Sweden  
Martinelli Luce  
The House Of Marley

**alberta**<sup>®</sup>  
Made in Italy

Alberta Pacific Furniture S.p.A.  
Via Toniolo, 41  
31028 Vazzola (TV) Italy  
Tel. +39 0438 440440  
Fax +39 0438 441555  
email: [contact@albertasalotti.it](mailto:contact@albertasalotti.it)

[www.alberta.it](http://www.alberta.it)

**alberta**<sup>®</sup>  
Made in Italy

ARGO	03
SPACE	29
RECANATI	39
MAISON	54
TOGO	64